



Experience hydration. Free your mind.

Discover how BRITA Water Dispenser Solutions elevate your organisation.

Drink better. Do better.

Contact us today: www.brita.net

Introducing Extra I-Tap

Timeless design meets advanced filter technology in a stylish tap dispenser.

- Elegant design in durable stainless steel
- Choice of four refreshing water types: unchilled and chilled still, chilled semi-sparkling and sparkling
- Choice of two capacities
- The dispenser conceals its powerful BRITA filtration technology and cooler capacity under the counter
- Outstanding hygiene through BRITA HygienePlus option – trusted by the healthcare industry for 20+ years



Extra I-Tap

Timeless design meets advanced filter technology in a stylish tap dispenser.



ThermalGate™ powerful thermal-disinfection feature



PureProtect smart self-cleaning feature



The optional BRITA HygienePlus fourfold safeguard is designed for environments with stringent hygiene requirements. This protects your dispenser from contamination and germs



Our water dispensers produce 85 % less CO₂ emissions than pre-bottled water and 61 % less than bottled water dispensers*



*Calculation based on Extra I-Tap 50 HP



Intuitive glass touch pad with pre-set portion control for glasses or bottles

Choice of two capacities

High-quality materials: Elegant design in durable stainless steel

Natural refrigerant and low power consumption



The **Easy Access Panel** helps create a barrier-free, inclusive working environment. The optional control unit can be positioned to provide easy access for wheelchair users

Extra I-Tap

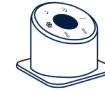

Technical data

Model	Extra I-Tap still + sparkling	
Design / Type	Tap System: I-Tap	Easy Access Panel
Types of water		
Configuration options		
Hygiene feature	BRITA ThermalGate™ or BRITA HygienePlus	
Tap height	330 mm dispensing height	
For installation in barrier-free environments		Easy Access Panel
For installation without waste water connection	Waste water container	
Specifications		
Cooling capacity	L cooler: 10–60 regular users XL cooler: 20–100 regular users	
Dimensions of undercounter appliances (W x H x D)	272 x 490 x 473 mm	
Dimensions of tap incl. drip tray (W x H x D)	132 x 453 x 216 mm	flat: 80 x 7 x 80 mm angled: 80 x 67 x 80 mm
Weight	tap: 2.5 kg undercounter appliance (L cooler): 33 kg undercounter appliance (XL cooler): 38.5 kg	0.5 kg
Max. power consumption	I-Tap with L cooler: 440 W I-Tap with XL cooler: 540 W	
Max. flow rate, still water	2 l/min	
Max. flow rate, sparkling water	1.6 l/min	

Introducing Easy Access Panel

Additional BRITA dispenser control unit for a barrier-free environment.

- Control unit can be positioned to provide easy access for wheelchair users
- Helps create a barrier-free, inclusive working environment
- Installs angled or flat for mounting on the counter or cabinet
- Available for different configurations of Top Pro, Extra I-Tap and Extra C-Tap



Easy Access Panel

Additional BRITA dispenser control unit for a barrier-free environment.



Design and operation
tailored to BRITA water dispensers



Barrier-free environment



Choice of water types in line with the installed BRITA water dispenser

Convenient positioning
Can be installed at various heights



Three installation options:

- Angled
- Flat: on countertop
- Flat: on cabinet front

Filtration power for your needs.

With BRITA's proven filtration solutions, you can be sure of excellent tasting water – meeting high hygiene, quality and environmental standards.



Activated carbon

Reduces substances that impair taste and odour.

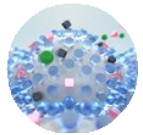

Ion exchanger

Minimises limescale and metals, e.g. lead.



Membrane

Filters out bacteria and cysts.

Whatever your local water condition is like, BRITA makes sure it works for your organisation. Staff stay hydrated more easily, guests enjoy a better experience, and patients can always rely on safe refreshment.

Filtration and hygiene that pay off for your business: our solutions protect your equipment, reduce service needs, and cut costs – all while fitting seamlessly into your daily routines.

Contact us today: www.brita.net



CLARITY Protect

Water filter: Reliably safe,
excellent water for your dispenser.

Reduces*:

- Particles such as microplastics and sand
- Per- and polyfluoroalkyl substances (PFAS)
- Metals such as lead
- Pharmaceuticals, pesticides and hormones
- Chlorine taste and odour
- Organic impurities
- Asbestos fibres
- Removes bacteria and microbial cysts

*If present in the tap water

Contact us today: www.brita.net



NSF component listed**

*applies to all materials that come into contact with water, ** Tested in a generic housing to a capacity of 11,500 l at 3 LPM for the reduction of Chlorine, Taste and Odour, and Cyst. Health effect testing per NSF/ANS Standard 53 (tested by an independent laboratory)

CLARITY Protect

Water filter: Reliably safe, excellent water for your dispenser.

Mains water is strictly controlled. But healthcare and similar environments where hygiene is of the utmost importance demand an extra level of safety. CLARITY Protect delivers this through multi-stage filtration, rather than a single activated carbon filter. CLARITY Protect sets the industry benchmark from the first stage of filtration to the moment your glass is filled with crystal-clear, refreshing water. We offer you over 50 years of filtration expertise in our "standard" filter.



The right balance — preserves minerals in water



CLARITY Protect reduces*:



Fine particles such as microplastics or sand



Metals such as lead



Pharmaceuticals, pesticides and hormones

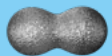

Chlorine taste and odour



Organic impurities



Bacteria and cysts



Asbestos fibres



PFAS

*If present in the tap water

Activated carbon filtration reduces substances that impair taste and odour

Pre-filter removes coarse particles



Hollow fibre membrane
Nominal pore size of 0.15 µm filters out 99.999 % of bacteria and 99.95 % of cysts

Filter capacity:
Protect: 11,500 l

Exceptionally clean, safe water

Protects equipment
lowering dispenser maintenance costs

CLARITY Protect



Technical data

Model	BRITA CLARITY Protect 100
Operating pressure	activated carbon and hollow fibre membrane filtration
Water intake temperature	4°C to 30°C
Ambient temperature for operation	4°C to 40°C
Ambient temperature for storage / transport	-20°C to 50°C
Water inlet and outlet connection	JG 8 mm
Operating pressure	2 bar to 8.6 bar
Flow rate at 1 bar pressure loss	180 l/h
Nominal filter capacity	11,500 l
Operating position	horizontal or vertical
Efficacy	
Reduction of particles such as microplastics or sand	≥ 0.5 µm (NSF 42, Class I)
Reduction of asbestos fibres	> 99.9 % (NSF 53 tested by independent laboratory)
Reduction of PFAS	> 99 % (NSF 53 tested by independent laboratory)
Reduction of metals such as lead	> 90 % (DIN EN 14898)
Reduction of chlorine	> 90 % (DIN EN 14898, Class I) and > 50 % (NSF 42)
Reduction of organic impurities such as benzene	> 90 %
Reduction of pharmaceuticals, pesticides and hormones such as naproxen, lindane, estrone	> 90 % up to at least 8,000
Reduction of bacteria	99.999 % (ASTM F838-20)
Reduction of cysts	99.95 % (NSF 53)
Dimensions (W x D x H)	
Filter system (filter head with filter cartridge)	68 x 68 x 338 mm
Filter cartridge	68 x 68 x 311 mm
Installed dimensions (vertical installation with wall mounting bracket)	68 x 74 x 371 mm

CLARITY Safe X3

Water filter: A bacterial filter for outstanding hygiene in critical environments.

Works in conjunction with CLARITY Protect and in addition:

Reduces*:

- Fine particles such as microplastics
- Bacteria
- Removes microbial cysts

*If present in the tap water

Contact us today: www.brita.net



KTW
tested*

ACS
conform



NSF component
listed**

*applies to all materials that come into contact with water, **applicable in combination with the water dispenser

CLARITY Safe X3



Water filter: A bacterial filter for outstanding hygiene in critical environments.

The CLARITY Safe X3 filter is an additional filter to CLARITY Protect in the BRITA HygienePlus solution. It sits just upstream of the dispenser outlet tap. When you draw water, CLARITY Safe X3 **reduces** any last remaining bacteria, microbial cysts and other unwanted impurities – right there and then. This final layer of protection **ensures** water of impeccable quality and hygiene every time.

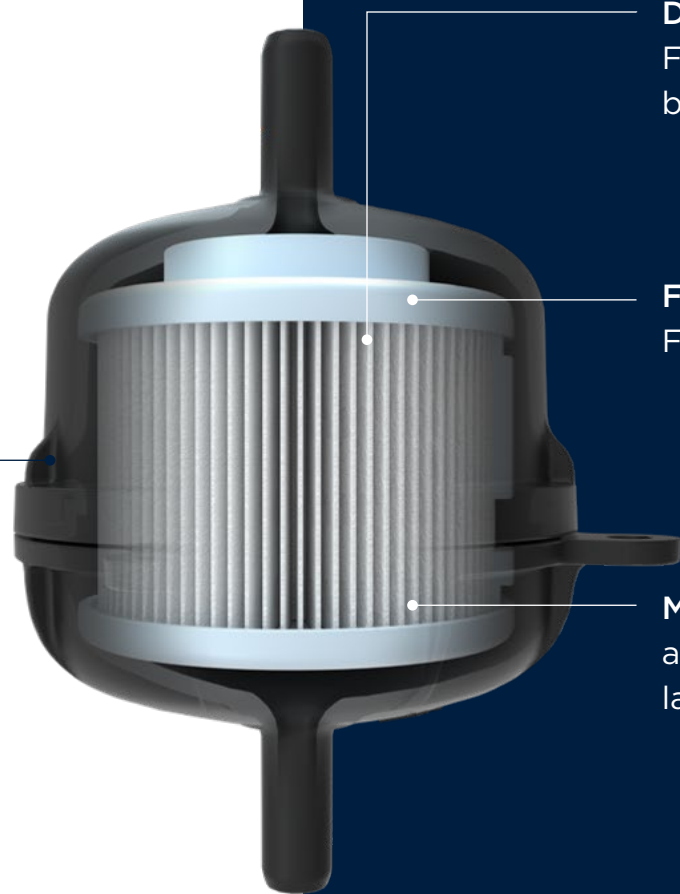

Double-layer membrane
Filters out 99.99999 % of bacteria and 99.95 % of cysts

Filter capacity:
Filter life of up to 6 months

Maximum safety via asymmetrical double-layer membrane

Second safeguard in combination with CLARITY Protect, filters water while dispensing



PURITY C Dispenser reduces*:



Fine particles such as microplastics



Fine particles such as sand



Bacteria



Microbial cysts

*If present in the tap water

CLARITY Safe X3



Technical data

Model	BRITA CLARITY Safe X3
Operating pressure	2 bar to 10 bar
Flow rate at 1 bar pressure loss	180 l/h
Nominal filter capacity	replace after 6 months
Particle retention	0.2 µm (nominal)
Reduction of bacteria	99.99999 % (ASTM F838-05)
Reduction of health contaminants such as cysts	99.95 % (NSF 53)
Operating position	Horizontal or vertical
Dimensions (W x D x H)	
Filter cartridge	86 x 86 x 112 mm



Hygiene you can count on.



Reliable protection –
from production to daily use.

With BRITA, hygiene is built in – from the very start. Every water dispenser is microbiologically tested, disinfected and delivered ready for use. On-site, our technicians follow strict safety procedures, ensuring seamless installation and long-term operational quality.

In daily use, the innovative BRITA HygienePlus feature combines our ThermalGate™, PureProtect, and advanced filtration technologies. Together, they safeguard water against bacteria, cysts, particles and unwanted substances – supporting your organisation with reliable hygiene and peace of mind in every environment.



BRITA ThermalGate™



Hygiene feature: The patented thermal disinfection solution from BRITA.

The tap of a typical water dispenser is exposed. A sneeze or touch of a hand can introduce germs. Without a robust safeguard, microorganisms on the wet tap can go on to contaminate the dispenser. That's why our BRITA water dispensers include our ThermalGate™ feature. This regularly heats the tap to protect against contamination automatically. You can sit back and relax – knowing your water dispenser has a proactive, powerful defence against germs, tested by an independent laboratory (Ruhr District Institute of Hygiene).

ThermalGate™, protected by patent
EP 3 793 795 B1 in the following countries:
AT, BE, CH, DE, FR, GB, IT, PL, NL, ES

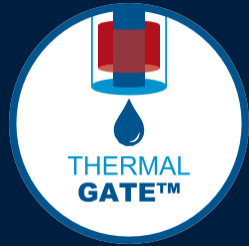

BRITA ThermalGate™

Hygiene feature: The patented thermal disinfection solution from BRITA.

The tap is automatically heated to over 125°C at regular intervals for thermal disinfection.

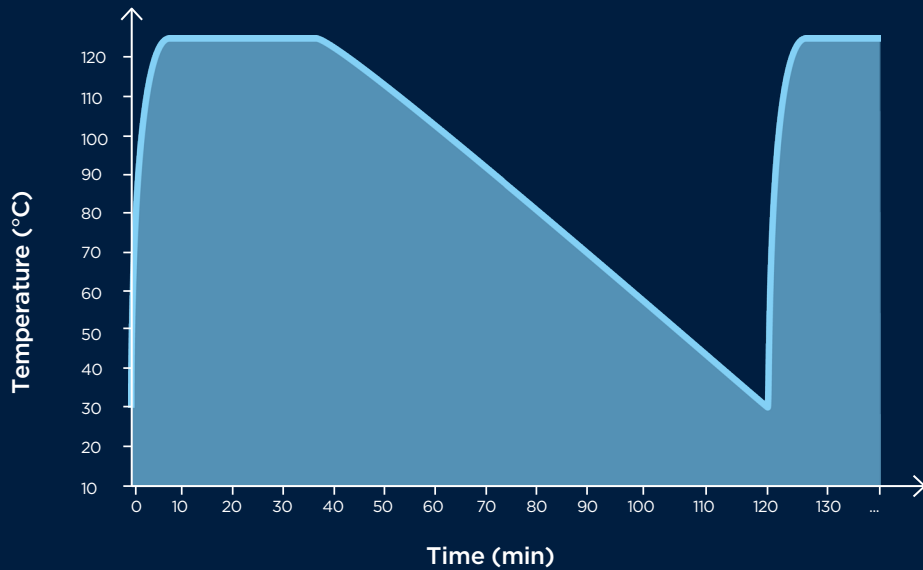

Contact us today: www.brita.net

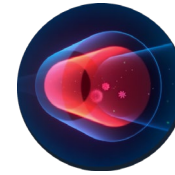

ThermalGate™
Protects against retrograde contamination.

ThermalGate™ is continuously active, providing protection not only at peak times, but also during periods of inactivity e.g., at night or on weekends

Does not require manual effort or chemical additives

Developed through over 20 years' experience in the healthcare market

ThermalGate™, protected by patent
EP 3 793 795 B1 in the following countries:
AT, BE, CH, DE, FR, GB, IT, PL, NL, ES

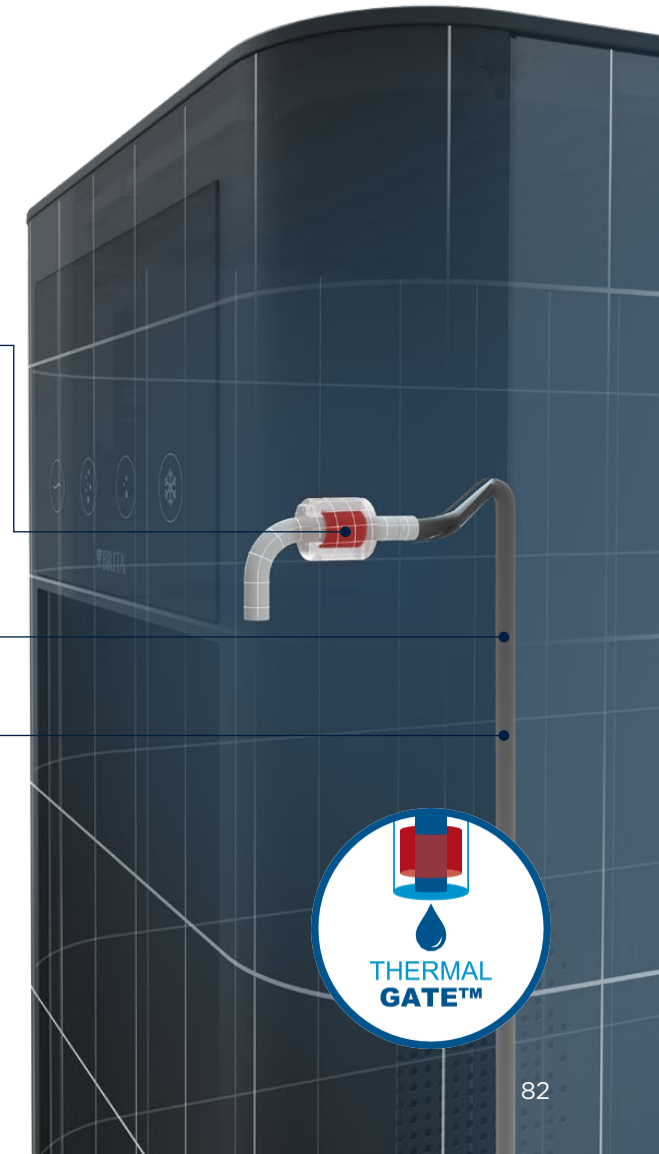

BRITA PureProtect

Inspiration from nature, innovation from BRITA.

In the world of nature, animals would rather drink from a running stream than a still pond. Their natural instinct has inspired PureProtect, our latest innovation for pristine drinking water. This smart self-cleaning feature complements and improves our trusted hygiene technology, giving you clean, pure-tasting water. Anytime and every time.

Water must flow! Our intelligent self-circulating mechanism makes sure that water never stands still.

It keeps water in the dispenser in motion, giving bacteria and germs no chance to settle and multiply. And with no flushing required, there's no wasted water, either.

Like running water, we at BRITA never stand still when it comes to fresh ideas for drinking water! PureProtect is the first self-circulating dispenser on the market: BRITA innovation, inspired by nature.

Watch our
video on
YouTube



Innovation first: BRITA is dedicated to new ideas and making the good even better. PureProtect is the first self-cleaning dispenser on the market.



Self-cleaning function: 99 % less germ and bacteria build-up with PureProtect when the dispenser is inactive.*



Continual filtration: The standing water volume of approx. 2 litres is circulated through the CLARITY Protect 100 inlet filter.



Taste the freshness: Our repeat activated carbon filtration ensures pure-tasting, refreshing water every time.



Smart adaptation: The smart system adapts to user behaviour. It adjusts cleaning frequencies based on usage patterns, ensuring optimal cleanliness and convenience, making your cleaning routine easier.



Sustainability: No flushing required! PureProtect saves 680 litres/year, cutting sanitisation water usage by 98 %.**



BRITA HygienePlus



This industry benchmark delivers the outstanding degree of protection demanded by hygiene-sensitive environments. We've developed it through over 20 years' experience working in the healthcare sector. An excellent filtration performance reduces potentially health-affecting bacteria, microbial cysts, microplastics, pharmaceuticals, legionella, and E. coli.

The BRITA HygienePlus solution consists of four safeguards, plus smart digital monitoring for additional safety. From the moment you draw water, our multi-stage filtration system is working together with smart monitoring. You can depend on fresh-filtered, hygienically pristine, crystal-clear water to quench thirst, every time.

BRITA HygienePlus has been tested in numerous studies at hygiene institutes, including the University Medical Centre of Johannes Gutenberg University Mainz, confirming microbiological safety according to DIN 6650-8.



BRITA HygienePlus

An industry benchmark hygiene feature.

- The BRITA CLARITY Protect filter at the inlet features a pre-filter for removing coarser particles, activated carbon filtration for taste and odour reduction, and hollow fibre membrane filters for removing pharmaceuticals, organic impurities, and metals like lead. The membrane filters out 99.999 % of bacteria and 99.95 % of cysts.
- PureProtect is BRITA's innovative self-cleaning feature. The standing water volume of approx. 2 litres is circulated through the Protect 100 inlet filter, ensuring thorough cleaning and ultimately improving taste. The smart system adapts to user behaviour, adjusting cleaning frequencies based on usage patterns.
- The BRITA CLARITY Safe X3, located upstream of the dispenser tap, employs a very fine, asymmetrical double-layer membrane to remove remaining bacteria and microbial cysts. It also filters out microplastics, 99.99999 % of bacteria, and 99.95 % of cysts.
- BRITA's powerful ThermalGate™ feature regularly heats the dispenser outlet tap automatically. This shields against contamination from external sources, such as touching the tap and aerosol droplets from sneezing or coughing.

Watch our
video on
YouTube

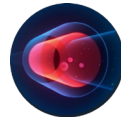

ThermalGate™
Protects against contamination from external sources

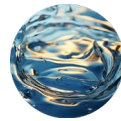

PureProtect
Smart cleaning function keeps water in continual motion, preventing bacteria and germ buildup

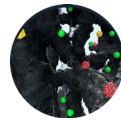

Activated carbon filtration
CLARITY Protect reduces substances that impair taste and odour

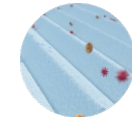

Double-layer membrane
CLARITY Safe X3 filters out 99.99999 % of bacteria and 99.95 % of cysts



Hollow fibre membrane
CLARITY Protect filters out 99.999 % of bacteria and 99.95 % of cysts



Pre-filter
CLARITY Protect removes particles

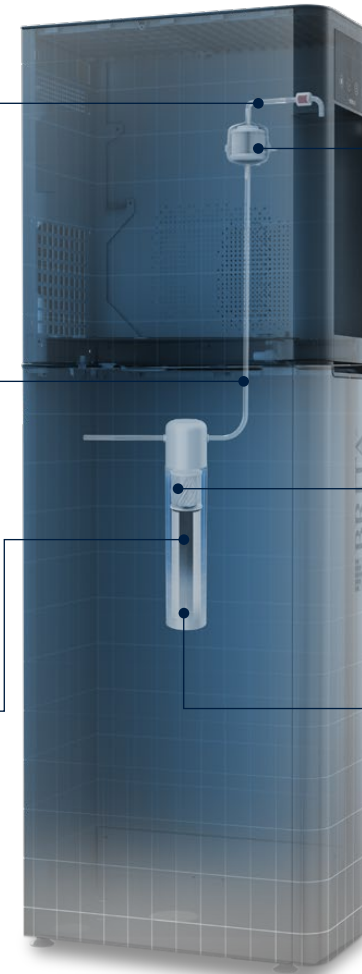

Hydration made easy.

Enhance your daily routines.

BRITA goes beyond dispensers and filters. Our accessories simplify every step of your hydration routine - from dispensing to serving and cleaning - so your organisation experiences water the way it should be: seamless and dependable.

Our premium bottles are designed for easy refills at your water dispenser. Durable and customisable, they fit neatly into dedicated crates for safe storage and transport. To keep hygiene effortless, we also provide practical washing systems and cleaning solutions for bottles and water dispensers.

Just choose whatever fits your needs - and empower your organisation with smoother daily routines and more sustainable workflows. Our best-practice tip? We recommend cleaning your BRITA Water Dispenser daily for extra peace of mind.



Looking for ways to reduce plastic bottle usage?

Replacing plastic bottles with long-lasting BRITA bottles and corresponding accessories is an easy way to make a difference.

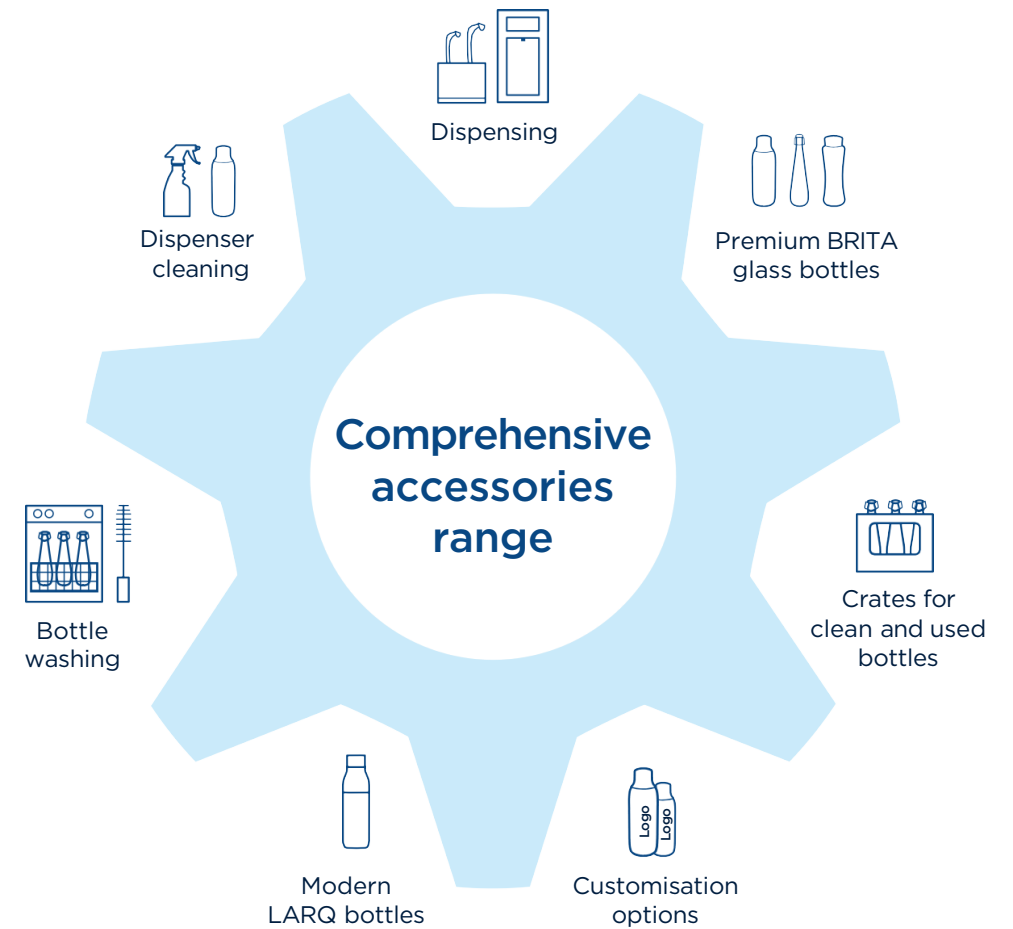



One partner. Zero hassle.



Everything you need for effortless drinking water.

BRITA Water Dispensers deliver refreshing, filtered water day in, day out — but the experience goes far beyond the dispenser itself. We install, maintain and keep every unit hygienically safe, so you never have to worry about availability.

Replace filters and adjust settings with our state-of-the-art BRITA Dispenser iQ Connect App. Your advantage? Precise diagnosis and error solving, leading to faster service resolution. One small app, but a significant step towards higher service quality!

We also offer financing, rental options and we're always on-hand to answer questions.

With a customised, comprehensive service package, you can enjoy our solutions with total peace of mind.

We're here for you.

Throughout the water dispenser lifecycle.

Safety through maintenance

Regular check-ups are essential for first-rate hygiene. We service water dispensers 1-2 times a year, supported by the BRITA Dispenser iQ Connect App - for clear data insights and maximum performance. Our rental and full-service contracts cover all repairs during the guarantee period.

Reliably high service quality

Our staff are regularly audited, and supervisors visit you to make sure every job meets your expectations in full. Continuous training programmes ensure our service quality stays at the highest possible level.

Advice and more - on tap!

Whether on-site or via hotline, our experts respond quickly and reliably, making sure you're completely satisfied at all times.



BRITA Service benefits

What you get from our full-service maintenance offering.



Cleaning

- Dispenser (interior/exterior) and base cabinet (for floorstanding dispensers)
- Chemical cleaning of all parts that come into contact with water
- Cooling unit fan and ventilation grille
- Drip tray and drain hose (where applicable)
- Dispenser tap and buttons or glass control panel



Visual inspection

- Robustness of dispenser and accessories
- Heat exchanger (cooling)
- Any exterior damage
- Any worn / defective parts
- Any potential leaks
- CO₂ hoses



Filter replacement

- BRITA filter(s) is replaced



Function test

- Set pressure/water (water pressure and pressure regulator)
- Function of the solenoid valves (timing)
- Carbonator-unit sensor probe
- Water meter check with digital/analogue documentation
- Buttons or touch display
- Temperature of dispensed water (cooling)
- CO₂ content (visual inspection of a glass of dispensed water)
- Flow rate of sparking/still water
- Electronics (in line with local requirements)
- BRITA ThermalGate™
- Safety valve of the carbonator-unit
- CO₂ pressure hose (CO₂ bottle / pressure regulator)
- Cooling unit



General

- Refresher training sessions for staff (optional)
- Digitally enhanced service with BRITA Dispenser iQ Connect App due to clear dispenser analysis
- Digital documentation of completed tasks

